

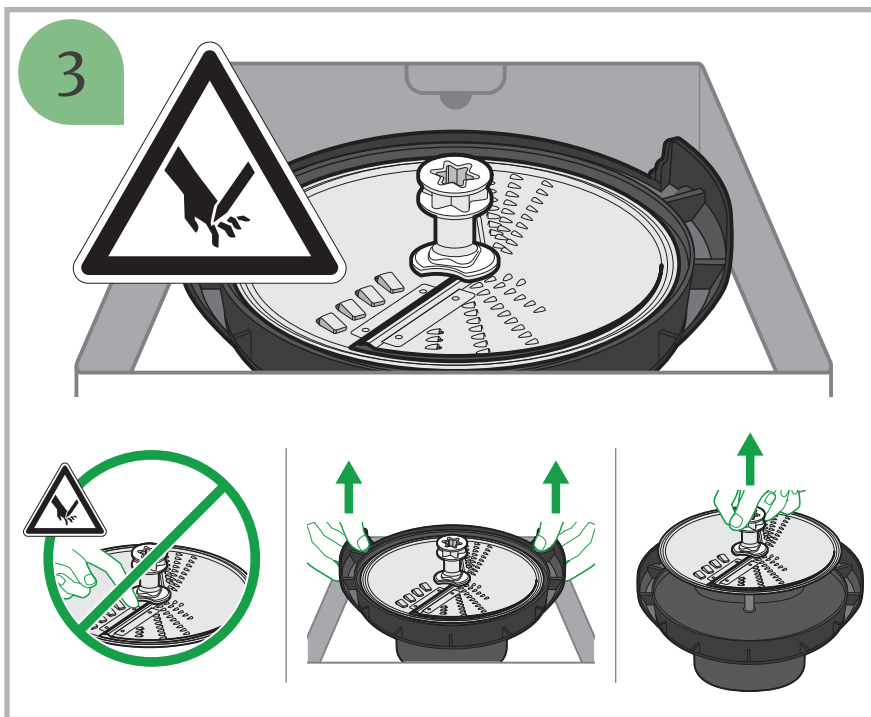

thermomix Cutter

VORWERK

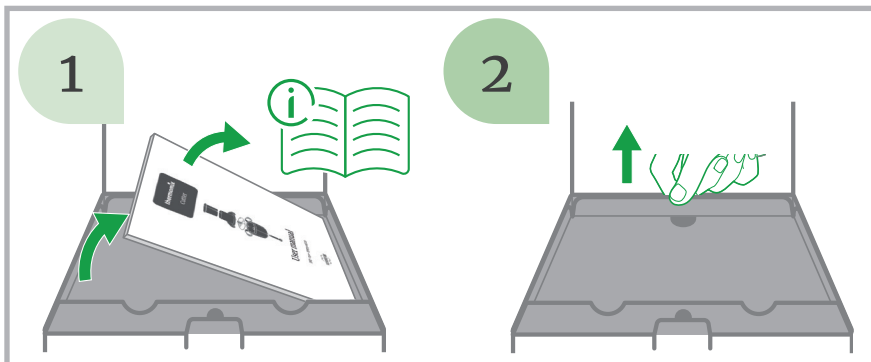

Quick Start • INT • V1.0 • 27074 06/22





5

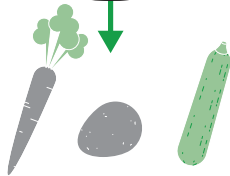
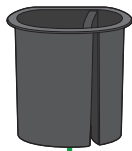

4

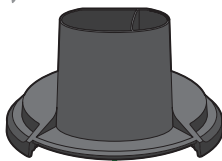

3

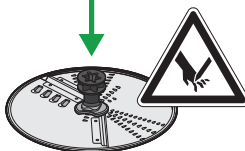

2

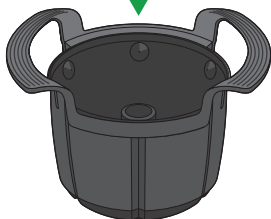

1

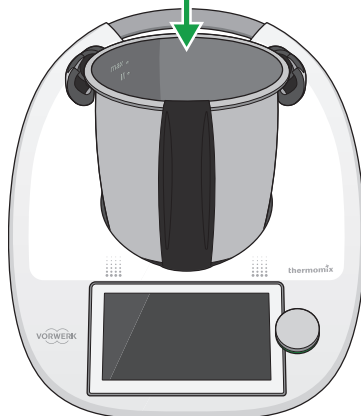

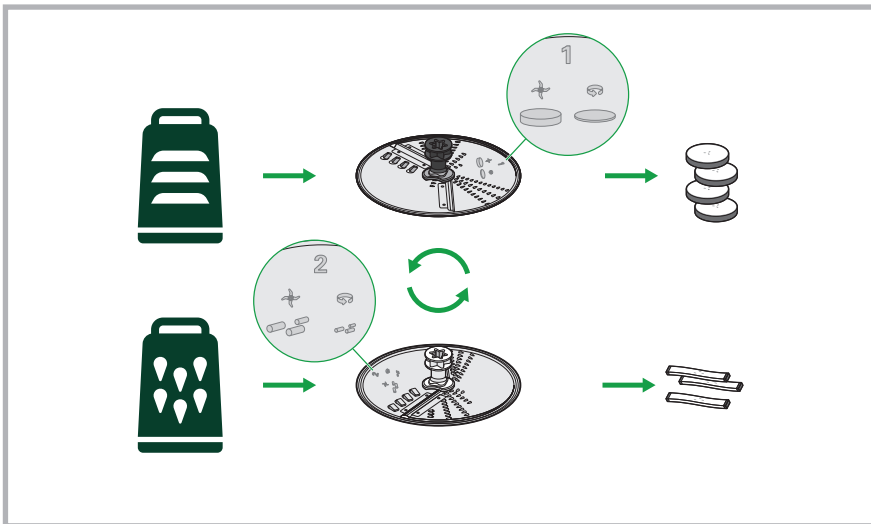

TM6

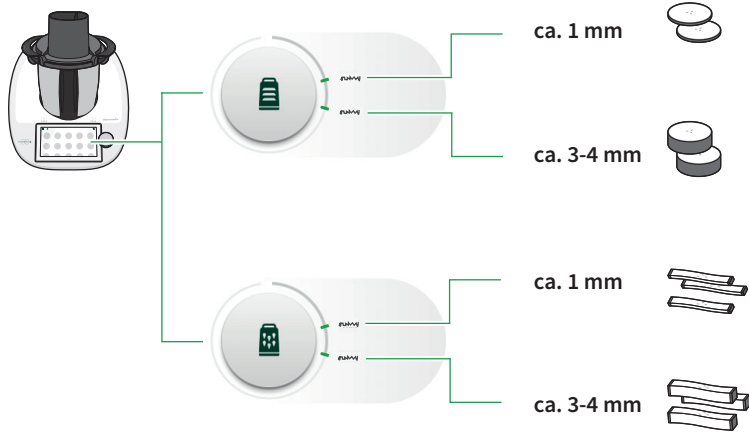

TM5

